

taurus



ENGLISH / AFRIKAANS

CUINA MESTRE

complies with
INTERNATIONAL
IEC60335
SAFETY SPECIFICATIONS

t
600W

2 YEAR
WARRANTY

Model:
913600

PLEASE READ ALL INSTRUCTIONS BEFORE USE



Parts list:

1. Cutting screw bar
2. Cutting disc
3. Cutting disc
4. Cutting disc
5. Blades
6. Worm shaft
7. Food pusher
8. Loading tray
9. Cutting meat canister
10. Stainless steel bowl
11. Rotating axis
12. Splash guard
13. Front protection cover
14. Rocker cover
15. Arm
16. Balloon whisk
17. Beater
18. Kneading hook
19. Meatball cannister
20. Cone- 21. Lead cover
- 22. Sausage horn
- 23. Rubber feet
- 24. Body
- 25. Knob
- 26. Control panel
- 27. Blender base
- 28. Blender blades
- 29. Glass jug
- 30. Lid
- 31. Filler cap

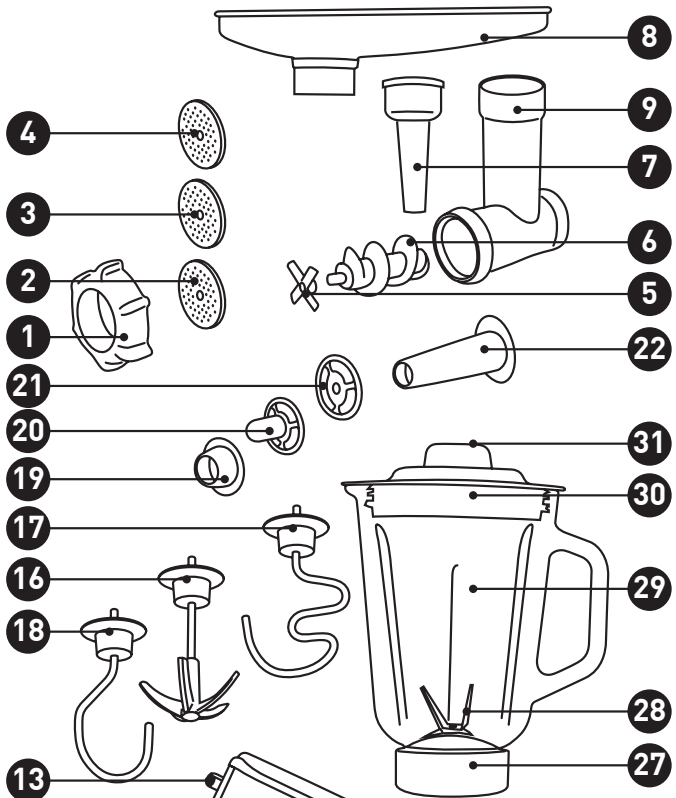

Parts list:

1. Snyskroefring
2. Snyderdisket
3. Snyderdisket
4. Snyderdisket
5. Lemme
6. Toevoerskag
7. Kosdrukker
8. Laaibak
9. Vleisnyhouer
10. Vlekvrye staalbak
11. Roterende as
12. Spatskern
13. Voorste beskermingomhulsel
14. Wegdekking
15. Arm
16. Ballonklitser
17. Klitser
18. Kniehaak
19. Frikkadelbak
20. Kegelvorm
21. Looddekking
22. Worsvoerpyp
23. Rubbervoete
24. Hoofdeel
25. Knop
26. Beheerpaneel
27. Mengerbasis
28. Mengerlemme
29. Glasbeker
30. Deksel
31. Filterdop

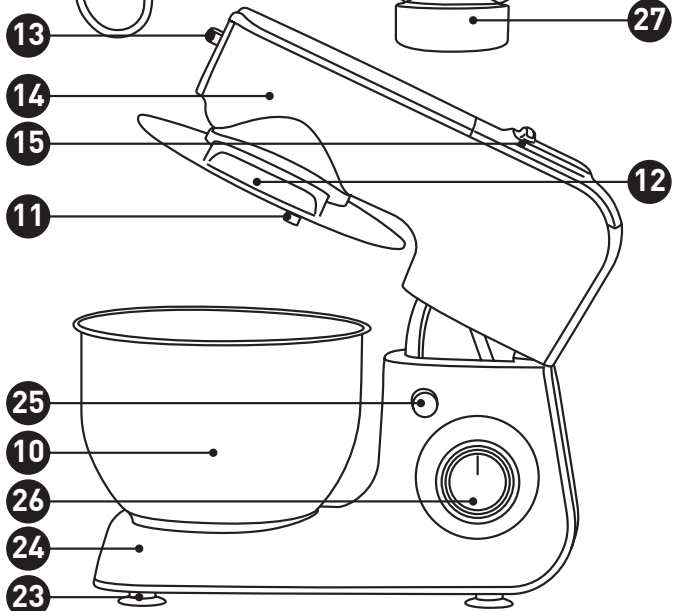

ENGLISH MANUAL

Dear customer,

Many thanks for choosing to purchase a TAURUS brand product.

Thanks to its technology, design and operation and the fact that it exceeds the strictest quality standards, a fully satisfactory use and long product life can be assured.

Important Safeguards:

When using electrical appliances, basic safety precautions should always be followed. Please read the following safety instructions and keep this instruction manual for future reference.

Before first use:

- Clean all the parts of the blender that will come into contact with food.
- Fully unwrap the power cord from the power cord storage before use.

Important safety precaution:

When using electrical appliance, basic precautions should always be followed including the following:

1. Read all instructions.
2. To protect against risk of electrical shock do not put the appliance unit cord or plug in water or other liquid.
3. Close supervision is necessary when an appliance is used by or near children.
4. Unplug the appliance when not in use, changing accessory and before cleaning
5. Avoid contacting moving parts.
6. If the supply cord is damaged, it must be replaced by manufacturer or its service agent or a similarly qualified person in order to avoid a hazard.
7. The use of attachments not recommended or sold by the manufacturer may cause fire, electrical shock or injury.
8. Do not use outdoors.
9. Do not let cord to hang over edge of table or counter.
10. Keep hands and utensils away from moving blades while processing food to reduce risk of severe injury to person or damage to the food mixer.
11. To reduce the risk of injury, never place cutting blades on base.
12. Turn off the machine before replace attachment.
13. Use the product and assembly the accessory as mentioned on user manual only
14. Switch off the appliance before changing accessories or approaching parts which move in use.
15. This appliance is not intended for use by persons (including children) with reduced physical, sensory or metal capabilities, or lack of experience and knowledge, unless they have been given supervision or instruction

Concerning use of the appliance by a person responsible for their safety.

16. Children should be supervised to ensure that they do not play with the appliance

Switch

OFF: Stop

Setting 1-5: Operating speed





Setting 1: Minimum speed---slow

Setting 5: Maximum speed---fast

P: Pulse function

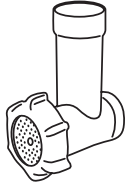
Speed Setting	Default Timer
1	8min
2	8min
3	8min
4	8min
5	8min

Recommend Speed Settings:

Accessories	Picture	Speed	Time
Meat Grinder		5	6min
Kneading Hook		1-2	6min
Beater		3-4	5min
Balloon		5	6min

Blender		5	3min
---------	---	---	------

Operating positions

Warning!



Do not operate the machine continuously more than 8 minutes at a time.

After one cycle of 8 minutes, the machine should be cooled down for 30minutes.

Do not use more than one function at same time.

Operate the appliance only when the accessory/tool is attached according to the below table and is in the operating position.

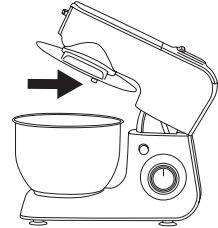
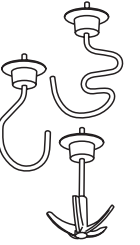
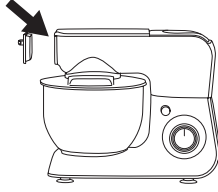
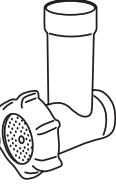
Always keep the bowl in the appliance when using it.

No.	Picture	Attachments
1		
2		
3		

running briefly.

How to use the beater attachments:

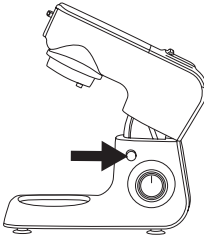
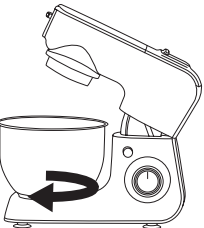
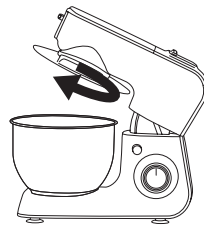
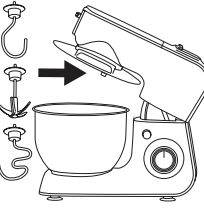
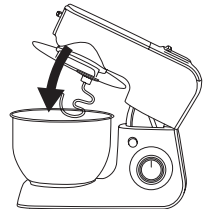
	1. Revolve the knob clockwise; meanwhile set the arm to the position as the picture shows
	2. Assemble the bowl filled with ingredients into base flute clockwise.
	3. Assembling the bowl cover into the arm clockwise.
	4. According to your desire, assemble beater, balloon wish or kneading hook into rotating axis then revolve them clockwise (As picture shows).
	5. Press arm down to the position as picture shows. Insert plug in socket Set switch to the appropriate speed

Risk of injury from the rotating tools!

While the appliance is in operation, keep fingers clear of the mixing bowl. Do not change tools until the appliance is at a standstill and has been unplugged. When switching off, the drive continues

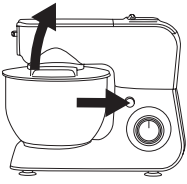
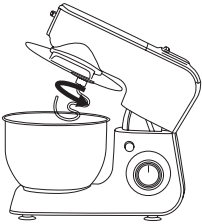
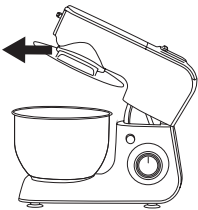
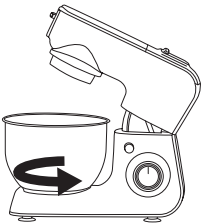
	<p>6. After food is ready, set the control panel to "OFF" then unplug. Turn the knob clockwise and set arm up to position as picture shows</p>
	<p>7. Remove beater, balloon whisk or kneading hook-Counter-clockwise.</p>
	<p>8. Remove bowl cover.</p>
	<p>9. Remove bowl with prepared food counter-clockwise</p>

How to use the meat grinder attachment:

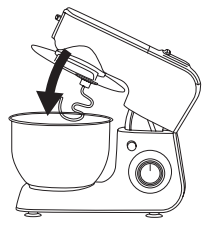
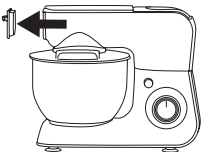
	<p>Press the arm down until you hear a "click".</p>
	<p>Take off the front protection cover upwards.</p>

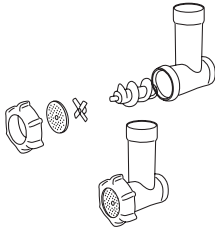
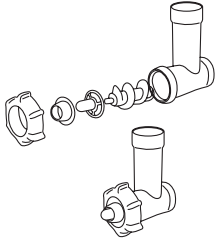
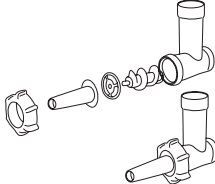
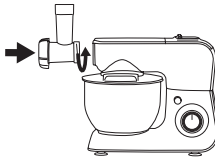
	<p>Following their sequence shown in the picture, assemble the worm shaft cutting blade and cutting disc into the Cutting meat canister, then assemble the cutting screw bar into the Cutting meat canister clockwise.</p>
	<p>Following their sequence shown in the picture, assemble the worm shaft, Conductor and meatball canister into the Cutting meat canister then assemble the cutting screw bar into the Cutting meat canister clockwise.</p> <p>* Please remember to disassemble the cutting cylinder from the machine, when changing these accessories.</p>
	<p>Following their sequence shown in the picture, assemble the Worm shaft, Lead cover and sausage canister into the cutting meat canister then assemble the cutting screw bar into the cutting meat canister clockwise.</p>
	<p>Align arrow on the cutting cylinder to the other one on arm then assemble prepared cutting meat canister into the arm counter-clockwise as shown in picture Fasten the cutting screw bar after the cutting meat canister is fixed correctly.</p>

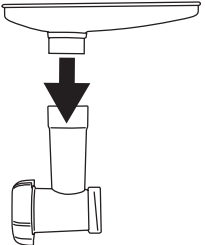
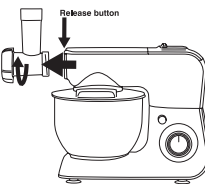
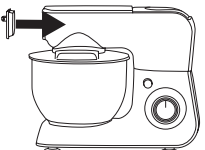
	<p>Assemble the loading tray into the cutting meat canister then place a bowl at the outlet of the cutting meat canister</p>
<p>Turn switch to the appropriate speed then put food into the feeding inlet with the food pusher to push down the food.</p>	
<p>Turn switch to "OFF" when the food is ready then unplug and cut off power. Remove pusher and loading tray.</p>	
	<p>Press the release button, remove the cutting meat canister from the arm clockwise.</p>
	<p>Assemble the front protection cover downwards, Do not use other functions when using the meat grinder.</p>

How to use the blender attachment:

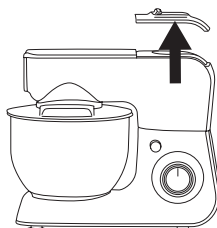
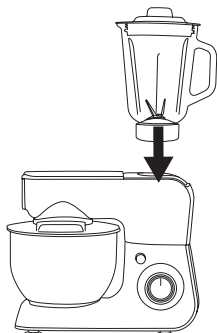
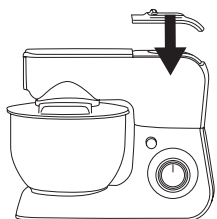
	<p>Open the safety cover Do not use other functions when using the blender.</p>
	<p>Put the glass jar, with food loaded and covered by lid, on the machine properly. Plug in machine. Set switch to '5' or 'p' Do not release the arm, when the glass jar on the machine.</p>
	<p>Put the safety cover back.</p>

Cleaning and servicing

Never immerse the base unit in water or hold the unit under running water. Do not use abrasive cleaning materials to clean.

Wipe the unit with a damp cloth, if required; use a little washing up liquid. Then wipe dry.

Wash attachments in hot, soapy water.



Rinse and dry thoroughly.

After washing and drying, immediately place attachments away for safe storage.

Capability of bowl

0.6kg flour and 0.3kg water.

Application examples

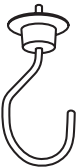
	<p>Beating of egg-white 3 egg-whites in the BOWL with the Balloon whisk at speed 5. Kb 6-8 min</p>
	<p>Beating of cream 300g cream with the Balloon whisk in the BOWL at speed 5 Kb 6-8 min</p>
	<p>Kneading of dough 600g flour 15g salt 28g butter 28g sugar app. 330g water (Temperature 40 +/- 2 °C). Kb eight minutes at speed 1</p>

AFRIKAANS HANDLEIDING

Geagte kliënt,

Baie dankie vir u keuse om 'n Taurus handelsmerk produk te koop. Danksy die tegnologie, ontwerp en werking en die feit dat dit voldoen aan die strengste gehalte standaarde, is u verseker van 'n volle bevredigende gebruik en lang produklewe.

Belangrike voorsorgmaatreëls:

Wanneer elektriese toestelle gebruik word, moet basiese veiligheidsmaatreëls altyd gevolg word. Lees asseblief die volgende veiligheidsinstruksies in die handleiding noukeurig deur en hou dit vir toekomstige verwysing.

Voor die eerste gebruik:

- Maak al die dele van die menger wat in kontak met kos gaan kom skoon.
- Haal al die verpakking van die kragkoord af voordat jy dit gebruik.

Belangrike veiligheidsmaatreël:

Wanneer die elektriese toestel gebruik word, moet basiese voorsorgmaatreëls altyd gevolg word, insluitende die volgende:

1. Lees al die instruksies.
2. Om teen die risiko van 'n elektriese skok te waak, moenie die toestel se koord of prop in water of enige ander ander vloeistof dompel nie.
3. Toesig is nodig wanneer die toestel naby of deur kinders gebruik word.
4. Ontkoppel die toestel wanneer dit nie in gebruik is nie, met die verandering van bybehore en voor dit gewas word.

5. Vermyn kontak met enige bewegende dele.
6. Indien die kragkoord beskadig is, moet dit vervang word deur die vervaardiger of sy diensagent of 'n soortgelyke gekwalifiseerde persoon om 'n ongeluk te vermy.
7. Moenie toebehore gebruik wat nie deur die vervaardiger verkoop of verskaf is nie, want dit kan 'n brand, elektriese skok of besering veroorsaak.
8. Moet nie die toestel buitekant gebruik nie.
9. Moenie toelaat dat die koord oor die rand van die tafel of toonbank hang nie.
10. Hou die hande en gereedskap weg van bewegende lemme tydens die verwerking van voedsel om die risiko te verminder van ernstige beserings aan 'n persoon of persone asook skade aan die kosmenger.
11. Om die risiko van besering te verminder, moet nooit die snylemme op die basis van die masjien sit nie.
12. Skakel die masjien af voor die vervanging van bybehore.
13. Gebruik die produk en die bybehore slegs soos genoem in die handleiding.
14. Skakel die toestel af voor die verandering van bykomstighede en wees versigtig met die bewegende dele.
15. Hierdie toestel is nie bedoel vir gebruik deur persone (insluitende kinders) met 'n verminderde fisiese, sensoriese, of 'n gebrek aan ervaring of kennis, tensy hulle deeglike onderrig gegee is onder toesig van 'n verantwoordelike persoon nie.
16. Kinders moet te alle tye onder toesig wees om te verseker dat hulle nie met die toestel speel nie.

Skakelaar

OFF: Stop

Stelling 1 – 5 werkingspoed





Stelling 1: Minimum spoed – stadig



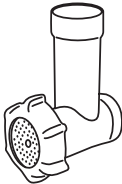
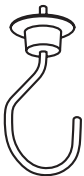

Stelling 5: Maksimum spoed – vinnig

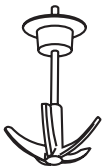
P: Polsfunksie

Spoedstelling	Vooraf bepaalde looptyd
1	8min
2	8min
3	8min
4	8min
5	8min

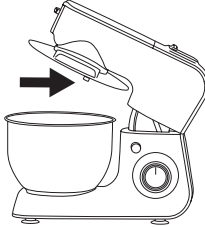
Aanbevole spoedinsettings:

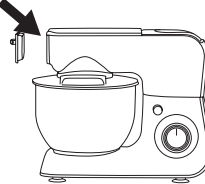
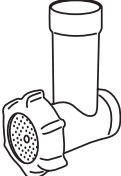
Bykoms-tighede	Illustrasie	Spoed	Tyd
Vleis maal		5	6min
Kniehaak		1-2	6min
Klitser		3-4	5min
Ballon		5	6min
Menger		5	3min

No.	Illustrasie	Bybehore
1		
2		
3		

Risiko van besering deur die roterende gereedskap!

Terwyl die toestel in werking is, hou vingers ver weg van die mengbak!

Moenie bybehore verander totdat die toestel nie meer aan die werk en ontkoppel is nie.

Wanneer die toestel afgekakel word, loop die motor nog vir 'n rukkie.

Werksposisies:

Waarskuwing!

Moet nie die masjien aanhoudend vir meer as 8 minute op 'n keer gebruik nie. Na een siklus van 8 minute moet die masjien eers afkoel vir 30 minute.

Moenie meer as een funksie op 'n keer gebruik nie.

Gebruik slegs die toestel met die bybehore/instrumente aangeheg volgens die onderstaande tabel en soos die werking daar aangedui word.

Hou altyd die bak in die toestel wanneer dit gebruik word.

Hoe om die klitser bybehore te gebruik:

	<p>1. Draai die knop kloksgewys; stel intussen die arm na die posisie soos aangedui in die illustrasie.</p>
	<p>2. Sit die bak gevul met bestanddele in die basisgroef en sluit dit kloksgewys vas.</p>
	<p>3. Sluit die bak se deksel kloksgewys in die arm.</p>
	<p>4. Soos jy dit mag nodig, gebruik die klitser, ballon, of kniehaak kloksgewys in die roterende as vasgesluit (sien illustrasie).</p>
	<p>5. Druk die arm af na die posisie soos die illustrasie toon. Koppel jou toestel aan die krag en draai dit na die vereiste spoed.</p>
	<p>6. Nadat die kos gereed is, stel die beheerpaneel na die "OFF" stelling. Draai die knop kloksgewys en stel die arm op soos die illustrasie toon.</p>

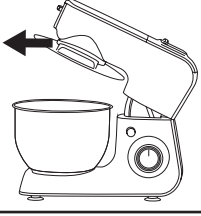
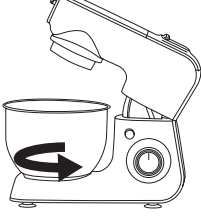
	<p>7. Verwyder die klitser, ballon en/of kniehaak teenkloksgewys .</p>
	<p>8. Verwyder die bakdeksel.</p>
	<p>9. Verwyder die bak met voorbereide voedsel teenkloksgewys.</p>

Hoe om die vleismeul te gebruik:

	<p>Druk die arm af totdat jy 'n "klikgeluid" hoor.</p>
	<p>Haal die voorkant se dekking opwaarts af.</p>
	<p>Volg die volgorde getoon in die illustrasies, plaas die toevoer skaglem en lemskyf in die vleis snyhouer, plaas dan die toevoerskroef kloksgewys in die toevoerskag.</p>

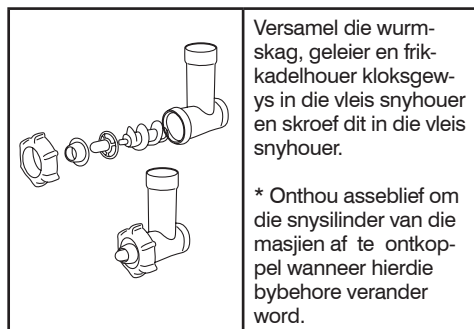

Versamel die wurmskag, geleier en frikkadelhouer kloksgewys in die vleis snyhouer en skroef dit in die vleis snyhouer.

* Onthou asseblief om die snysilinder van die masjien af te ontkoppel wanneer hierdie bybehore verander word.



Gebruik die volgorde in die illustrasies om die wurmas, looddeksel en worshouer in die vleis snyhouer saam te stel en dan die wurmskag kloksgewys in die vleissnyhouer te sit.



Rig die pyl regoor die een op die snysilinder en die een op die arm en stel dan die voorbereide vleishouer teenkloksgewys soos in die illustrasie aangedui. Maak dan die snyskroef vas sodra die vleis snyhouer korrek vasgesit is.



Stel die laaibak op in die vleis snyhouer en sit 'n bakkie by die uitlaattuit van die vleishouer.

Draai die skakelaar na die toepaslike spoed en plaas kos in die toevoer inlaat met die kosstoter om die kos af te druk.

Draai die skakelaar na die "AF" posisie wanneer die kos gereed is en ontkoppel die krag. Verwyder die kosstoter en die laaibak.



Druk die uitskietknoppie, verwyder die vleis snyhouer kloksgewys van die arm.



Versamel die voordekking deur afwaarts te druk. Moenie ander funksies gebruik as die vleismeule gebruik word nie.

Hoe om die menger se bybehore te gebruik:



Maak die veiligheidsdekking oop. Moet nie die ander funksies gebruik wanneer die menger in gebruik is nie.

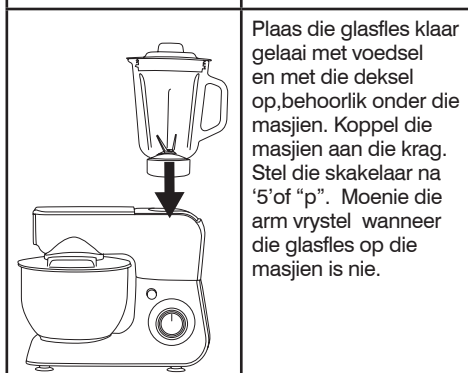

Plaas die glasflles klaar gelaai met voedsel en met die deksel op,behoorlik onder die masjien. Koppel die masjien aan die krag. Stel die skakelaar na '5' of "p". Moenie die arm vrystel wanneer die glasflles op die masjien is nie.

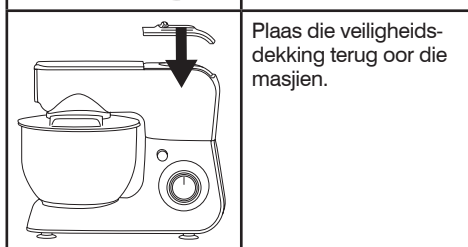

Plaas die veiligheidsdekking terug oor die masjien.

Skoonmaak en diens:



Moet nooit die basiseenhed in water of enige ander vloeistof dompel of onder 'n lopende kraan laat nie. Moenie skuurprodukte gebruik vir skoonmaak nie. Vee dietoestel met 'n klam doek af as dit nodig is;gebruik 'n klein bietjie opwasmiddel op die doek en vee af. Droog dit dan af.

Was bybehore in warm seperige water. Spoel dit dan af en droog dit deeglik af. Na die was en afdroog, stoor dadelik die bybehore op 'n veilige plek.

Kapasiteit van die bak:

0.6kg flouer en 0.3kg water.

Voorbeelde van aanwending:

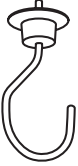
	Klop van eierwit: 3 eierwitte in die BAK met die ballon daarop en klits op spoed 5. K 6-8 minute.
	Klop room: 300g room met die ballon klits in die BAK op spoed 5. K 6-8 minute.
	Knie deeg: 600g meel, 15g sout, 28g botter, 28g suikerapp, 330 g water (Temperatuur 40 +/- 20 C). K 8 minute op spoed 1.

taurus

**2 YEAR
WARRANTY**

**1 YEAR RETAIL
+1 YEAR EXTENDED**

taurusappliances.co.za
Register Online

Thank you for purchasing a Taurus product. Taurus guarantees that your product has been thoroughly inspected and tested before being dispatched and is free from mechanical and electrical defects and complies with the applicable safety standards. With every Taurus product purchased you get a 2 year warranty as detailed in the terms and conditions below.

First Year – 1 Year Retail Warranty:

Should defects due to faulty parts or workmanship develop, under normal domestic use, within 12 months from the original date of purchase please return the product to the store from where it was purchased for a refund or replacement.

Second Year – 1 Year Extended Warranty

Taurus takes pride in their product quality and therefore offer an extended 12 month warranty over and above the 1 Year Retail Warranty. Should defects due to faulty material or workmanship develop, under normal domestic use, after the 12 month period and within 24 months from the original date of purchase, please return the product postage pre-paid to Taurus for repair. Taurus will repair the product free of charge and return it to you directly. Taurus will replace a product with a similar product in the same or better condition, if the repair cannot be conducted for whatever reason. NB: The 1 Year Extended Warranty is only valid for customers who have registered their warranty online at www.taurusappliances.co.za within the first year after making their purchase. See overleaf for details and instructions.

Before returning your product, check the following:

- Your household mains supply socket is in good condition, working and switched on.
- The mains supply circuit is not overloaded (White trip switch on your DB board is off).
- You have read the trouble shooting guide in your Instructions for Use.
- All accessories and parts are present.

The following conditions apply:

1. Please ensure you retain your receipt as this must be presented when making a claim under the terms of the guarantee. It is impossible to determine the guarantee period without proof of purchase, so please keep this in a safe place. (NB. Your guarantee can be scanned onto the Taurus web site for safe storage – see reverse side for details.)
2. If a refund or exchange is required the product must be complete with all accessories, parts and packaging. Missing parts will render the guarantee void.
3. Upon receipt of your appliance, check it for any transport damage to ensure it is safe for use. Return it to the store as soon as possible for exchange if damaged. The guarantee is void if products are damaged after

use, so please do not use the damaged product.

4. Your product is designed for normal domestic household use. Failure to read and comply with the instructions for use, cleaning and maintenance will render your guarantee void, so please read these instructions carefully to ensure your safety, and to get the most effective use from the product. (e.g. not removing lime scale; water deposits; insect infestation, and/or burnt products)
5. Any abuse, negligent, improper or accidental use or care will render the guarantee void and Creative Housewares (Pty) Ltd will not be liable for any loss or damage.
6. Any attempted repair, or replacement of unauthorised parts will render the guarantee void, so please contact an authorised service centre or service agent for any service or repair requirements.
7. NB: The guarantee on replaced products will be from the original date of purchase and not from when the date replacement was made.
8. All repairs carry a 3 month guarantee even if this falls outside of the 2 year guarantee period.
9. Taurus will attempt to conduct repairs within reasonable time in line with industry standards but cannot be held responsible or liable for any circumstances not under our control.

Repairs Out of the Warranty Period

If service or repair becomes necessary outside the warranty period, this service is still available however all transport/postage, spares and labour costs will be for the customers' account. All chargeable repairs will require the customers' written acceptance of the quote. Once the go-ahead has been received Taurus will undertake to conduct the repair within a reasonable time and maintain the condition of the product as received. All repairs are guaranteed for 3 months from the date of the repair.

For any service, enquiries and complaints please contact our Customer Care on 086 111 5006 or e-mail help@creativehousewares.co.za from 08h00 to 15h00 Monday to Friday excluding public holidays. Please also note that the company is normally closed for 2 weeks around Christmas and New Year.

Please send all products for repair postage pre-paid to one of the service centres listed on the back of this page.

ONLINE WARRANTY REGISTRATION

Why register your warranty?

We at Taurus pride ourselves on bringing premium quality appliances to market, and as a commitment to this level of quality we offer a 2 year warranty (1 Year Retail + 1 Year Extended) on all of our products. We often hear that our customers lose their receipts and can therefore no longer claim if they have a problem. To take advantage of the 1 Year Extended Warranty you will need to register your warranty online within the first year of purchase in order to make a valid claim. Now you can register your product, upload your warranty online, never have to worry about losing your receipt again and enjoy the benefit of your 2 year warranty.

Added Benefits

In addition to providing you with an online profile of your registered products we will also provide a host of value added benefits:

- Incentives and Competitions for registered users
- New recipes or ideas for your products
- New product developments – be the first to get the latest appliances
- Special offers on promotional items

How to Register your Online Warranty?

STEP1 Create your user profile:

If you haven't done so already, simply visit www.taurusappliances.co.za, click on the "Product Registration" link and follow the easy instructions. You will receive a username and password once registered. This will give you access to your user profile.

STEP2 Pick a registration method:



DESKTOP/ LAPTOP

- Open your internet browser and visit www.taurusappliances.co.za
- Click on the "Registration" link and login using your user name and password.
- Click on "Register your products and upload receipts" and follow the easy instructions.
- Scan and upload your receipt



SMART PHONE/ TABLET

- Scan the QR code above or visit www.taurusappliances.co.za
- Click on the "Registration" link and login using your user name and password.
- Click on "Register your products and upload receipts" and follow the easy instructions.
- Scan or take a photo and upload your receipt.



FAX

- Fax the following to 021 931 4058
- First Name and Surname
- Contact telephone and fax number.
- Product Model number and Type.
- Traceability Code (found on the Warranty Card or on a label on the product)
- A clear and legible copy of your receipt.

Notes:

1. The online warranty system is a safe storage facility for your receipt.
2. You will be required to register on the Taurus website. You will receive a username and password once registered. This will give you access to your profile.
3. From your profile you will be able to load products that you have purchased. In order to successfully register your warranty you will need to use either scan and upload, or fax through your receipt to us.
4. All instructions on how to load your products are available

inside your profile.

5. Please note that you must check that your receipt has been uploaded correctly. Creative Housewares cannot be held responsible for faxes or files not received.
6. For assistance with registration please email: marketing@creativehousewares.co.za.

NB: Your 1 year extended warranty is only valid if your product is registered online within the first year after purchasing your Taurus product. Failure to register your product on-line within the first year will render the extended warranty as void.

creative housewares

National Service Centre: 086 111 5006
e-mail: help@creativehousewares.co.za
www.creativehousewares.co.za

Cape Town

20 Tekstiel Street, Parow, Cape Town, 7493,
South Africa • P.O. Box 6156 Parow East, 7501,
South Africa Tel: +27 21 931 8117
Fax: +27 21 931 4058

Durban

35 Adrian Road, Windermere,
Durban, South Africa, 4001
Tel: +27 31 303 3465
Fax: +27 31 303 8259

Johannesburg

9 Hamburg Road, Airport, Spartan,
Johannesburg, South Africa
Tel: +27 11 392 5652
Fax: 086 567 9222

taurus



Dankie vir die aankoop van 'n Taurus produk. Taurus waarborg dat u produk deeglik geïnspekteer en getoets word voordat dit versend word en is vry van meganiese en elektriese gebreke en voldoen aan die toepaslike veiligheidsstandaarde. Met elke Taurus produk wat gekoop word kry u 'n 2 jaar waarborg soos uiteengesit in die terme en voorwaardes hieronder.

Eerste Jaar - 1 Jaar Kleinhandelswaarborg:

Indien defekte as gevolg van foutiewe onderdele of vakmanskap binne 12 maande onder normale huishoudelike gebruik ontwikkel, binne die 12 maande vanaf die oorspronklike datum van aankoop, neem asseblief die produk na die winkel van waar dit gekoop is vir 'n terugbetaling of vervanging.

Tweede Jaar - 1 Jaar Uitgebreide Waarborg

Taurus is trots op die kwaliteit van die produk en bied dus 'n uitgebreide 12 maande waarborg bo en behalwe die 1 Jaar Kleinhandelswaarborg. Indien defekte as gevolg van foutiewe materiaal of vakmanskap ontwikkel, onder normale huishoudelike gebruik, na die 12 maande tydperk en binne 24 maande vanaf die oorspronklike datum van aankoop, stuur die produk terug met posgeld betaal na Taurus vir herstel. Taurus sal die produk gratis herstel en dit direk aan u terugstuur. Taurus sal die produk vervang met 'n soortgelyke produk in dieselfde of beter toestand, as die herstel nie uitgevoer kan word vir watter rede ookal nie.

NB: Die 1 Jaar Uitgebreide waarborg is slegs geldig vir kliënte wat hul waarborg geregistreer het op ons webtuiste by www.taurusappliances.co.za binne die eerste jaar nadat hulle dit aangekoop het. sien keersy vir besonderhede en instruksies.

Voordat u die produk terug stuur, maak seker van die volgende:

- U huishoudelike geleidingsok is in 'n goeie toestand, werk en aangeskakel is,
- Die geleidingsok is nie oorlaai nie (Wit uitskop skakelaar op u DB bord af is),
- U het die moeilikheid steuringsgids gelees in u instruksies vir gebruik,
- Alle bykomstighede en dele teenwoordig is.

Die volgende voorwaardes geld:

1. Maak seker dat u kwitansie behoue is, dit moet aangebied word wanneer 'n eis gemaak word onder die voorwaardes van die waarborg. Dit is onmoontlik om die waarborg tydperk te bepaal sonder die bewys van aankoop, so hou dit asseblief in 'n veilige plek. (NB. U waarborg kan opgeskandeer word na die Taurus webtuiste vir veilige bewaring - sien keersy vir meer inligting.)
2. Indien 'n terugbetaling of omruiling van die produk nodig is moet die produk volledig wees met al die bykomstighede, onderdele en verpakking. Toebehore wat weg is sal die waarborg nietig maak.
3. Met ontvangs van u toestel, gaan dit na vir enige vervoer skade om te verseker dat dit veilig is vir gebruik. Stuur dit so gou as moontlik terug na die winkel om die beska-

digde toestel te vervang. Die waarborg is nietig indien die beskadigde produk gebruik word na die tyd, so moet asseblief nie die beskadigde produk gebruik nie.

4. U produk is ontwerp vir normale huishoudelike gebruik. Deur te versuim om die instruksies te lees en te voldoen aan die terme van gebruik, die skoonmaak en instandhouding van die produk maak u waarborg ongeldig, so lees asseblief hierdie instruksies versigtig om u veiligheid te verseker, en om die beste uit die gebruik van die produk te kry. (bv nie die verwydering van kalk skaal; water neerslag; insek besmetting, en / of verbrande produkte)
5. Enige misbruik, nalatige, onbehoorlike of toevallige beskadiging of sorg van die produk word die waarborg nietig en Creative Housewares (Pty) Ltd, sal nie aanspreeklik wees vir enige verlies of skade nie.
6. Enige poging tot herstel, of vervanging met ongemagtigde onderdele sal die waarborg nietig maak, so kontak 'n gemagtigde dienssentrum of diensagent vir enige diens of herstelwerk.
7. NB: Die waarborg op die vervangingsproduk sal by die oorspronklike datum van aankoop bly en nie van die datum wanneer dit vervang is nie.
8. Alle herstelwerk dra 'n 3 maande waarborg selfs al val dit buite die 2-jaar waarborg tydperk.
9. Taurus sal probeer om die herstelwerk te doen binne 'n redelike tyd in lyn met die industrie standaard, maar kan nie verantwoordelik gehou word of aanspreeklik wees vir enige omstandighede nie onder ons beheer nie.

Herstelwerk buite die waarborg tydperk

As diens of herstelwerk benodig word buite die waarborg tydperk, is hierdie diens steeds beskikbaar, maar is alle vervoer / posgeld, onderdele en arbeidskoste op die kliënte se onkoste. Alle betaalbare herstelwerk sal skriftelike aanvaarding van die kwotasie vereis van die kliënt. So dra Taurus die groen lig ontvang sal ons onderneem om die herstel binne 'n redelike tyd en in dieselfde toestand te hou as wat die produk ontvang is. Alle herstelwerk is gewaarborg vir 3 maande vanaf die datum van die herstel.

Vir enige diens, navrae en klagtes kontak ons kliënte diens op 086 111 5006 of e-pos help@creativehousewares.co.za vanaf 08h00 tot 15h00, Maandag tot Vrydag, openbare vakansiedae uitgesluit. Let asseblief ook daarop dat die maatskappy gewoonlik gesluit is vir 2 weke gedurende Kersfees en Nuwejaar.

Stuur asseblief alle produkte vir herstel met posgeld vooruit betaal aan een van die dienssentrums wat op die agterkant van hierdie bladsy verskyn.

AANLYN WAARBORG REGISTRASIE

Hoekom moet u die waarborg moet registreer?

Ons by Taurus is trots om premium gehalte toestelle op die mark te bring, en as 'n verbintenis tot die vlak van gehalte bied ons 'n 2 jaar waarborg (1 Jaar Kleinhandel + 1 Jaar Uitgebreide) op al ons produkte. Ons hoor dikwels dat ons kliënte hul kwitansies verloor en kan dus nie meer eis as hulle 'n probleem het nie. Om voordeel te trek van die 1 Jaar Uitgebreide waarborg sal u nodig hê om u waarborg aanlyn te registreer binne die eerste jaar van aankoop om 'n geldige eis te maak. Nou kan u die produk aanlyn registreer, laai u waarborg en hoef u nooit te bekommer dat u die kwitansie sal verloor nie en die voordeel van u 2-jaar waarborg geniet.

Bygevoegde Voordele

Bykomend tot die verskaffing van 'n aanlyn profiel van u geregistreerde produkte bied ons ook vele ander toegevoegde waarde voordele:

- aansporings en kompetisies vir geregistreerde gebruikers
- nuwe resepte of idees vir u produkte
- nuwe produk ontwikkelings - die eerste wees om die nuutste toestelle te kry
- spesiale aanbiedings op promosie-items

Hoe om u Aanlyn Waarborg te Registreer?

STAP 1 Skep u gebruikersprofiel:

As u dit nie reeds gedoen het nie, besoek www.taurusappliances.co.za, klik op die "Product Registration" skakel en volg die maklike instruksies. U sal 'n gebruikersnaam en wagwoord ontvang sodra u geregistreer het. Dit sal u toegang tot u profiel gee.



taurusappliances.co.za

STAP 2 Kies 'n registrasie metode:



REKENAAR/ SKOOTREK- ENAAR

- Maak u internet snuffelgids oop en besoek www.taurusappliances.co.za
- Klik op die "Registrasie" skakel en teken in met u gebruikersnaam en wagwoord.
- Klik op "Register your products" en laai kwitansies en volg die maklike instruksies.
- Skandeer en laai u strokie



SMART- FOON / TABLET

- Skandeer die QR-kode bo of besoek www.taurusappliances.co.za
- Klik op die "Registration" skakel en teken aan met u verbruikersnaam en wagwoord.
- Klik op "Register your products" en laai u kwitansie en volg die maklike instruksies.
- Skandeer of neem 'n foto en laai u strokie.



FAKS

- Faks die volgende na 021 931 4058
- Naam en Van
- Kontak telefoon en faksnommer.
- Produk model nommer en tipe.
- Traceability Code (wat op die Waarborgkaart of op 'n etiket op die produk gevind kan word)
- 'n Duidelike en leesbare afskrif van u ontvangs.

Notas:

1. Die aanlyn waarborg stelsel is 'n veilige stoor fasiliteit vir u strokies.
2. U sal gevra word om op die Taurus webtuiste te registreer. U sal 'n gebruikersnaam en wagwoord ontvang. Dit sal u toegang gee tot u profiel.
3. Van u profiel u sal in staat wees om produkte te laai wat u gekoop het. Om u waarborg suksesvol te registreer sal u nodig hê om of te skandeer en oplaai, of faks u strokie deur na ons.
4. Alle instruksies oor hoe om u produkte te laai is beskikbaar binne in u profiel.
5. Let daarop dat u moet seker maak dat u kwitansie korrek op-

gelaai is. Creative Housewares kan nie verantwoordelik gehou word vir faks- of lêers nie ontvang nie.

6. Vir hulp met registrasie e-pos asseblief: marketing@creative-housewares.co.za.

NB: U 1 jaar verlengde waarborg is slegs geldig indien u produk aanlyn geregistreer is binne die eerste jaar na die aankoop van u Taurus produk. Indien u produk nie aanlyn geregistreer word binne die eerste jaar nie sal dit die verlengde waarborg nietig maak.

creative housewares

Nasionale Dienssentrum: 086 111 5006
e-pos: help@creativehousewares.co.za
www.creativehousewares.co.za

Kaapstad

20 Tekstielstraat, Parow, Kaapstad, 7493, Suid Afrika • PO. Box 6156 Parow Oos, 7501, Suid Afrika Tel: +27 21 931 8117
Faks: +27 21 931 4058

Durban

35 Adrianweg, Windermere, Durban, Suid Afrika, 4001
Tel: +27 31 303 3465
Faks: +27 31 303 8259

Johannesburg

9 Hamburgweg, Aeroport, Spartan, Johannesburg, Suid Afrika
Tel: +27 11 392 5652
Faks: 086 567 9222

creative housewares



20 Tekstiel St, Parow, Cape Town, 7493, RSA



P.O. Box 6156 Parow East, 7501, RSA



+27 21 931 8117



+27 21 931 4058

Service Centre Helpline: 086 111 5006



www.creativehousewares.co.za